

THIS DOCUMENT IS THE PROPERTY OF
KEYSTONE ELECTRONICS CORP. AND
SHALL NOT BE REPRODUCED, DISTRIBUTED
OR USED AS A BASIS FOR MANUFACTURE
WITHOUT PRIOR WRITTEN PERMISSION
FROM KEYSTONE ELECTRONICS CORP.

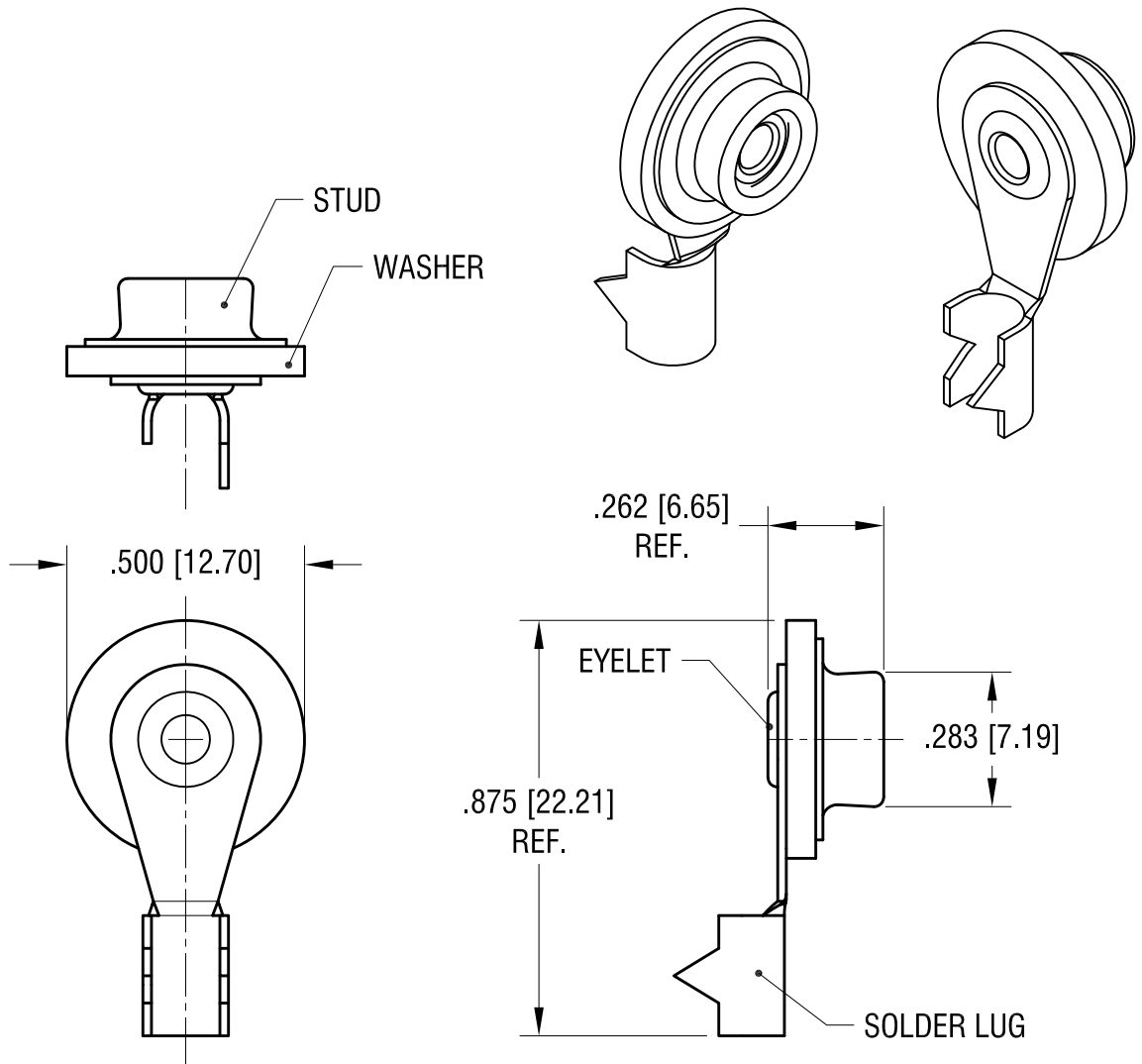

NOTE:

1. SOLDER LUG: MAT'L BRASS
FINISH- MATTE TIN PLATE
2. STUD: MAT'L- BRASS
FINISH- NICKEL PLATE
3. WASHER: MAT'L PHENOLIC
4. EYELET: NAT'L- BRASS
FINISH- TIN PLATE

REF. P/N MOD.264
REF. P/N Z4152RAM

12.03.09	CHANGE AS PER ECR 09-018	A
DATE	DESCRIPTION	REV.

KEYSTONE ELECTRONICS CORP.			
www.keyelco.com • ASTORIA, N.Y. 11105-2017 • Tel (718) 956-8900			
PART NAME		SNAP-ON	
MATERIAL		AS NOTED	
FINISH		DRN BY	DATE
AS NOTED		NT	9.28.09
		APP'D	SCALE
			2.5X
TOLERANCES	INCH [MM]	CODE	DWG NO.
DECIMAL	± .010 [± 0.25]	C	9-264-WPW
ANGULAR	± 1°		
UNLESS OTHERWISE SPECIFIED			