

THIS DOCUMENT IS THE PROPERTY OF
KEYSTONE ELECTRONICS CORP. AND
SHALL NOT BE REPRODUCED, DISTRIBUTED
OR USED AS A BASIS FOR MANUFACTURE
WITHOUT PRIOR WRITTEN PERMISSION
FROM KEYSTONE ELECTRONICS CORP.

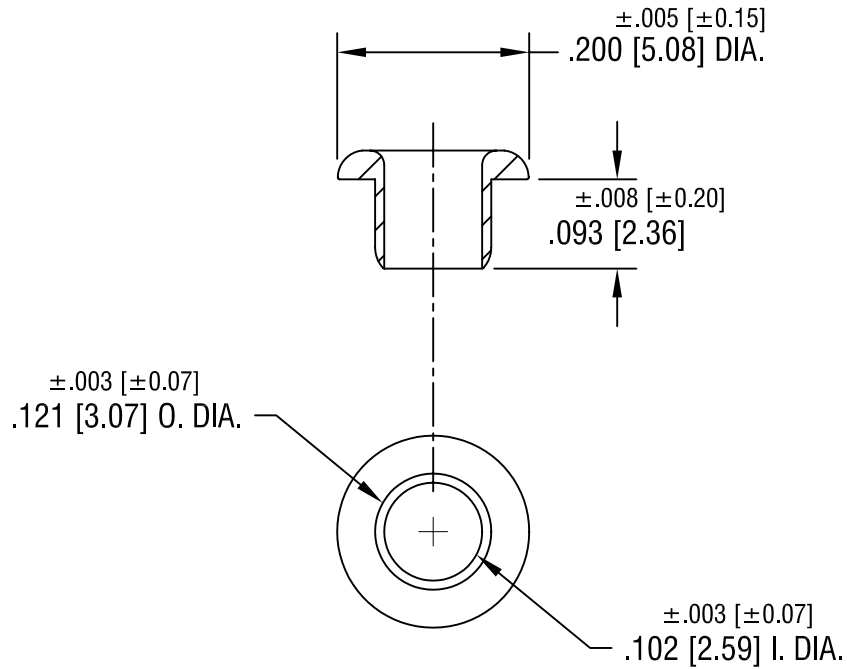

KEYSTONE ELECTRONICS CORP.			
ASTORIA, N.Y. 11105-2017			
PART NAME		WIDE ROLL EYELET	
MATERIAL		.0095 [0.24] TH'K BRASS	
FINISH		DRN BY	DATE
TIN PLATE		BOONE	6.14.94
		APPD	SCALE
		LN	5X
TOLERANCES	INCH [MM]	CODE	DWG NO.
DECIMAL	$\pm .005 [\pm 0.15]$	C/M	43
ANGULAR	$\pm 1^\circ$		
UNLESS OTHERWISE SPECIFIED			

DATE	DESCRIPTION	REV.