

THIS DOCUMENT IS THE PROPERTY OF  
KEYSTONE ELECTRONICS CORP. AND  
SHALL NOT BE REPRODUCED, DISTRIBUTED  
OR USED AS A BASIS FOR MANUFACTURE  
WITHOUT PRIOR WRITTEN PERMISSION  
FROM KEYSTONE ELECTRONICS CORP.

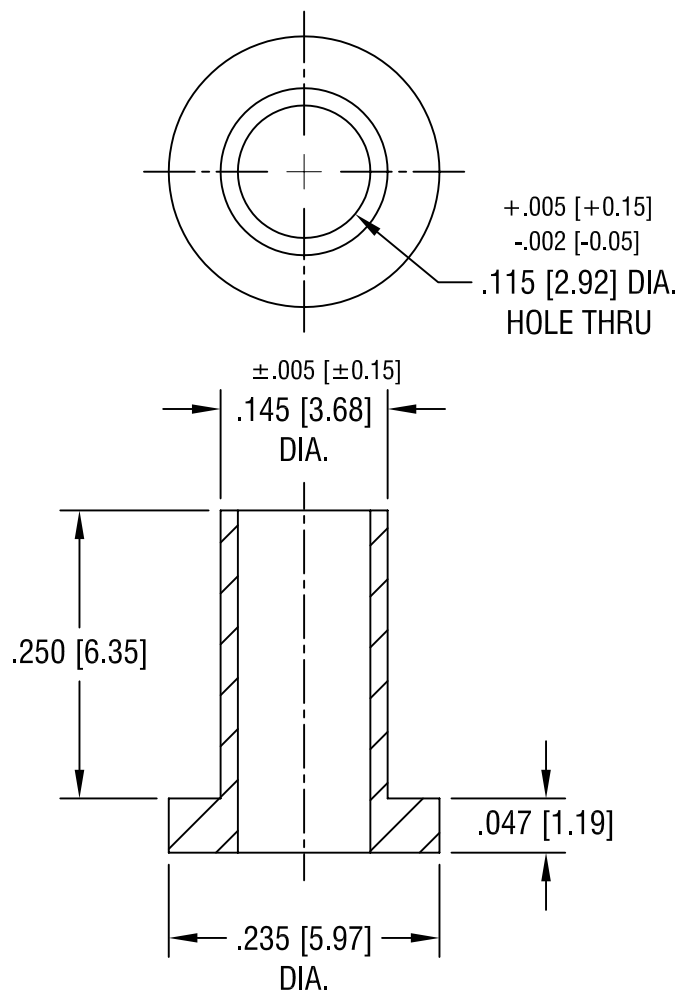

**KEYSTONE ELECTRONICS CORP.**

ASTORIA, N.Y. 11105-2017

PART NAME

NYLON SHOULDER WASHER

MATERIAL

NYLON 6/6

FINISH

-

DRN BY

BOONE

DATE

5.3.06

APP'D

LN

SCALE

6X

TOLERANCES

INCH [MM]

DECIMAL  $\pm .010 [\pm 0.25]$

ANGULAR  $\pm 1^\circ$

UNLESS OTHERWISE SPECIFIED

CODE

C/M

DWG NO.

340

DATE	DESCRIPTION	REV.