

THIS DOCUMENT IS THE PROPERTY OF  
KEYSTONE ELECTRONICS CORP. AND  
SHALL NOT BE REPRODUCED, DISTRIBUTED  
OR USED AS A BASIS FOR MANUFACTURE  
WITHOUT PRIOR WRITTEN PERMISSION  
FROM KEYSTONE ELECTRONICS CORP.

ACTUAL SIZE

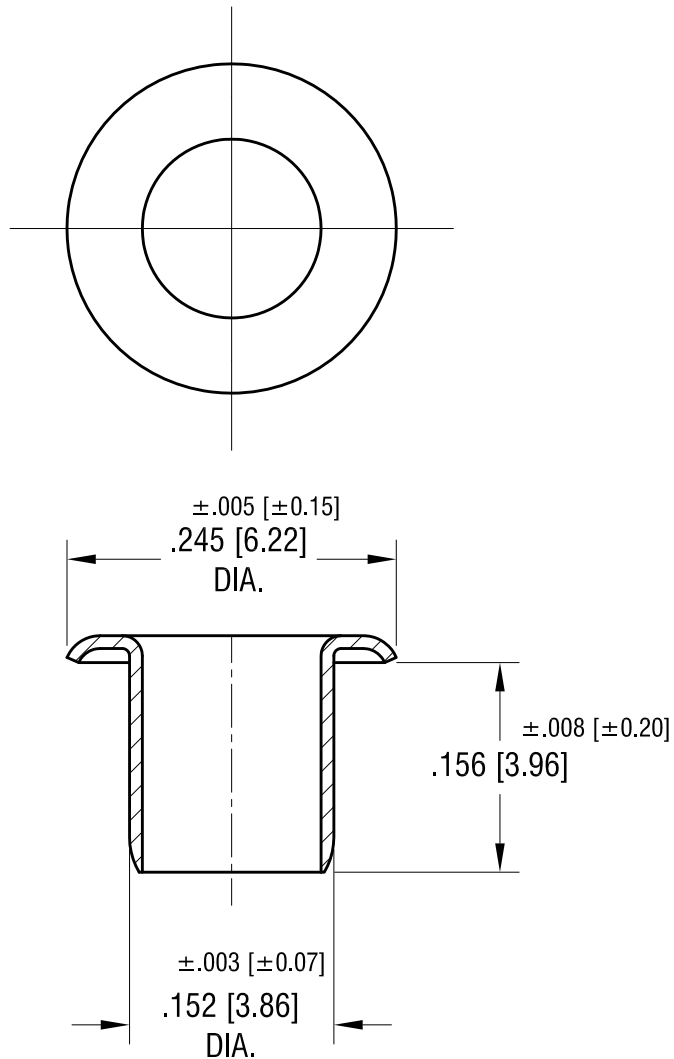

**KEYSTONE ELECTRONICS CORP.**

www.keyelco.com • ASTORIA, N.Y. 11105-2017 • Tel (718) 956-8900

PART NAME

WIDE ROLL EYELET

MATERIAL

.010 [0.25] TH'K BRASS

FINISH

TIN PLATE

DRN BY

NT

DATE

1.17.13

APP'D

LN

SCALE

7X

TOLERANCES

INCH [MM]

DECIMAL  $\pm .005$  [ $\pm 0.13$ ]

ANGULAR  $\pm 1^\circ$

UNLESS OTHERWISE SPECIFIED

CODE

C

DWG NO.

15

DATE

DESCRIPTION

REV.